

DIELECTRIC UNION



TECHNICAL DATA

DESCRIPTION:

- Prevents electrolysis or galvanic action when connecting dissimilar materials
- High corrosion resistance
- Smooth interior
- Models available to satisfy all state and federal low-lead laws
- Certified to NSF/ANSI 61 & 372

PART#	DESCRIPTION
DU-PRSXFIP-2	2" PRS X 2" FIP DIELECTRIC UNION

Country of origin: China

ROUGH IN DRAWING

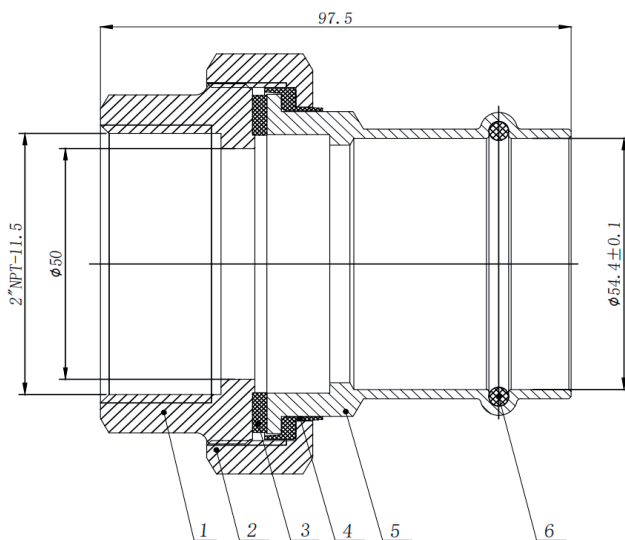

6	O-RING	EPDM	1
5	COMPRESSION CONNECTOR	BRASS	1
4	INSULATOR SLEEVE	PA66	1
3	WASHER	EPDM	1
2	NUT	STEEL(Q235)	1
1	CONNECTION	STEEL(Q235)	1
No.	DESCRIPTION	MATERIAL	Qty

ALL DIMENSIONS SHOWN ARE NOMINAL